

Thermik Integral

Allzweck-Grillpfanne	122
Bain-Marie	122
Ceranfeld	126 - 128
Frittenwanne	121
Fritteusen	121
Gasherde	129 -131
Grillplatte, Elektro	123
Grillplatte, Elektro, hartverchromt	124
Grillplatte, Elektro-Duplex	125
Schaschlik-Pfanne	122





D-FRE-60-120



D-BME-60



D-GRE-60

Elektro • 600 mm Bautiefe

Material CNS 1.4301



	Artikel	Typ	Preis Einzelgerät €
	Einzelfritteuse 1 Becken, 225 x 340 x 180 mm Nutzfüllmenge ca. 9 l mit Beckendämmung herauschwenkbarer Heizkörper Korbgröße: 200 x 280 x 100 mm 400 x 600 mm	6 kW D-FRE-40-60	1.903,-
		7,5 kW D-FRE-40-75	1.978,-
		10 kW D-FRE-40-100	2.130,-
	Doppelfritteuse 2 Becken, 225 x 340 x 180 mm Nutzfüllmenge 2 x ca. 9 l mit Beckendämmung 2 herauschwenkbare Heizkörper Korbgröße: 200 x 280 x 100 mm 600 x 600 mm	12 kW D-FRE-60-120	3.064,-
		15 kW D-FRE-60-150	3.263,-
		20 kW D-FRE-60-200	3.569,-
	Jumbo-Fritteuse Großraum-Back- und Frittiergerät Beckengröße 1/1 GN-195 mm Nutzfüllmenge ca. 23 l mit Beckendämmung 2 herauschwenkbare Heizkörper großer Fettablaß nach unten Körbe: 2 x 220 x 280 x 100 1 x 475 x 260 x 100 15 kW / 400 V Achtung: Fettablass nach unten	D-J-FRE-15	3.302,-
	Fritten-Wanne 1/1 GN Beheizung und Beleuchtung durch Infrarotstrahler 0,5 kW / 230 V 400 x 600 mm	D-BSE-40	1.511,-

5

Elektro • 600 mm Bautiefe

Material CNS 1.4301



	Artikel	Typ	Preis Einzelgerät €
	Bain-Marie Tiefgezogenes Becken 195 mm Geeignet für Behälter 1/1 GN bis 150 mm Höhe indirekte Beheizung 1,5 kW / 230 V 400 x 600 mit Beckendämmung NEU	D-BME-40	1.661,-
	Bain-Marie Tiefgezogenes Becken 195 mm Geeignet für Behälter 1/2 GN bis 150 mm Höhe indirekte Beheizung 2,25 kW / 230 V 600 x 600 mit Beckendämmung NEU	D-BME-60	1.947,-
	Bain-Marie Tiefgezogenes Becken 195 mm Geeignet für Behälter 2/1 GN bis 150 mm Höhe indirekte Beheizung 3,0 kW / 230 V 800 x 600 mit Beckendämmung NEU	D-BME-80	2.041,-
	Allzweck-Grillpfanne Wannenmaß 500 x 500 x 140 mm Wanneninhalt 25 l 7,2 kW / 400 V 600 x 600 mm Achtung: Ablauf nach unten	D-AG-60	3.610,-
	Schaschlik-Pfanne Schaschlikpfanne mit Spezial- Leichtmetallpfanne Wannenmaß 265 x 465 x 70 mm 3,9 kw / 400 V 400 x 600 mm	D-BRE-40	1.724,-

Elektro • 600 mm Bautiefe Grillplatten Stahl

- Bratfläche aus fein geschliffenem Stahl
- Platte ist versenkt und von oben hygienisch dicht verschweißt.
- Gleichmäßige Hitzeverteilung mittels Alu-Heizkern System
- Stufenlose Regelung über Thermostate bis zu einer Temperatur von ca. 250°C
- Material Rahmen CNS 1.4301

	Artikel	Typ	Preis Einzelgerät €
	Grillplatte Glatte Bratfläche 400 x 550 mm 1 Heizzone 4,55 kW 450 x 600 mm	D-GRE-40	1.654,-
	Grillplatte Glatte Bratfläche 600 x 550 mm 2 Heizzonen 7,15 kW 650 x 600 mm	D-GRE-60	2.136,-
	Grillplatte Glatte Bratfläche 800 x 550 mm 2 Heizzonen 9,75 kW 850 x 600 mm	D-GRE-80	2.621,-
	Grillplatte Bratfläche 1/2 gerillt / 1/2 glatt 600 x 550 mm 2 Heizzonen 7,15 kW 650 x 600 mm	D-GRE-60R	2.723,-

5



Elektro • 600 mm Bautiefe Grillplatten Stahl hartverchromt

- Bratfläche aus fein geschliffenem Stahl
- Platte ist versenkt und von oben hygienisch dicht verschweißt.
- Gleichmäßige Hitzeverteilung mittels Alu-Heizkern System
- Stufenlose Regelung über Thermostate bis zu einer Temperatur von ca. 250°C
- Material Rahmen CNS 1.4301

	Artikel	Typ	Preis Einzelgerät €
	Grillplatte Hartverchromt Hartverchromte Bratfläche glatt 400 x 550 mm 1 Heizzone 4,55 kW / 400 V 450 x 600 mm	D-GRE-40-C	2.327,-
	Grillplatte Hartverchromt Hartverchromte Bratfläche glatt 600 x 550 mm 2 Heizzonen 7,15 kW / 400 V 650 x 600 mm	D-GRE-60-C	2.726,-
	Grillplatte Hartverchromt Hartverchromte Bratfläche glatt 800 x 550 mm 2 Heizzonen 9,75 kW / 400 V 850 x 600 mm	D-GRE-80-C	3.111,-



Elektro • 600 mm Bautiefe Grillplatten Duplex

- Bratfläche aus **Einkomponenten-Duplex-Edelstahl**
- Platte ist versenkt und von oben hygienisch dicht verschweißt
- Gleichmäßige Hitzeverteilung mittels Alu-Heizkern System
- Stufenlose Regelung über Thermostate bis zu einer Temperatur von ca. 250°C
- Material Rahmen CNS 1.4301

	Artikel	Typ	Preis Einzelgerät €
	Grillplatte Glatte Duplex Bratfläche 400 x 550 mm 1 Heizzone 4,55 kW / 400 V 450 x 600 mm	D-GRE-40-D	3.046,-
	Grillplatte Glatte Duplex Bratfläche 600 x 550 mm 2 Heizzonen 7,15 kW / 400 V 650 x 600 mm	D-GRE-60-D	3.650,-
	Grillplatte Glatte Duplex Bratfläche 800 x 550 mm 2 Heizzonen 9,75 kW / 400 V 850 x 600 mm	D-GRE-80-D	4.420,-

5



Ihre Vorteile:

- **Bratfläche mit minimaler Hitzeabstrahlung, ideal für den Frontcooking-Bereich**
- **Einfache Reinigung der Bratfläche mittels Wasser, ein Einölen der Bratfläche nach der Benutzung entfällt**

Anwendungsvideo hier:



Elektro • 600 mm Bautiefe Einbau-Cerankfelder



Material Einbaurahmen CNS 1.4301

	Artikel	Typ	Preis Einzelgerät €
	<p>2-Felder-Cerankocher vorn 1,7 kW Ø 180 mm hinten 2,1 kW Ø 220 mm 3,8 kW, 400 V Kochfeldgröße 350 x 495 mm x 6 mm 400 x 600 mm</p>	<p>D-C-600-2</p>	<p>2.736,-</p>
	<p>4-Felder-Cerankocher vorn 2 x 1,7 kW Ø 180 mm hinten 2 x 2,1 kW Ø 220 mm 7,6 kW, 400 V Kochfeldgröße 695 x 495 mm x 6 mm 800 x 600 mm</p>	<p>D-C-600-4</p>	<p>3.623,-</p>

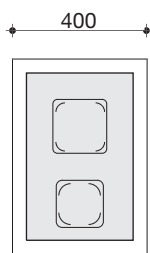

Glasmaß 350 x 595 x 6 mm

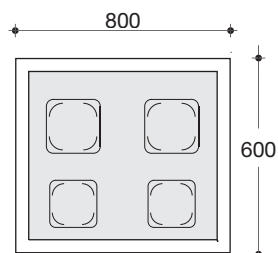

695 x 595 x 6 mm

 = 1,7 kW
Ø 180 mm

 = 2,1 kW
Ø 220 mm



MADE IN GERMANY

Elektro • 700 mm Bautiefe Einbau-Ceranfelder

Material Einbaurahmen CNS 1.4301

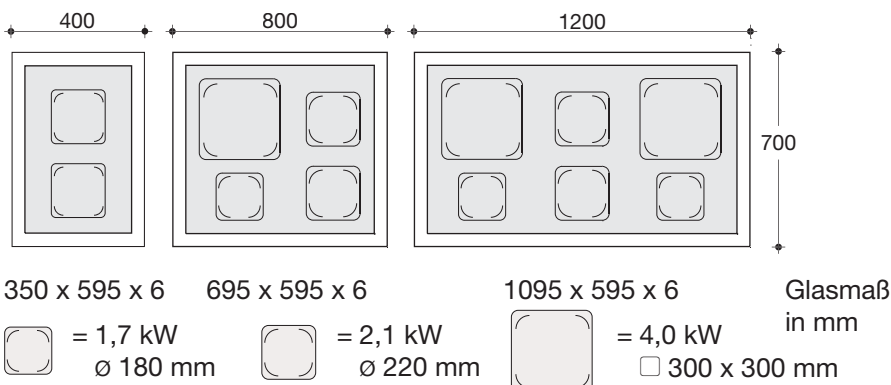

	Artikel	Typ	Preis Einzelgerät €
	Einbau-Ceranfeld 2-Felder 2 x 2,1 kW Ø 220 mm 4,2 kW, 400 V Kochfeldgröße 350 x 595 mm x 6 mm 400 x 700 mm	D-C-700-2	3.379,-
	Einbau-Ceranfeld 4-Felder 1 x 4,0 kW 300 x 300 mm 2 x 2,1 kW Ø 220 mm 1 x 1,7 kW Ø 180 mm 9,9 kW, 400 V Kochfeldgröße 695 x 595 mm x 6 mm 800 x 700 mm	D-C-700-4	5.179,-
	Einbau-Ceranfeld 6-Felder 2 x 4,0 kW 300 x 300 mm 2 x 2,1 kW Ø 220 mm 2 x 1,7 kW Ø 180 mm 15,6 kW, 400 V Kochfeldgröße 1095 x 595 mm x 6 mm 1200 x 700 mm	D-C-700-6	6.520,-



Elektro • 800 mm Bautiefe Einbau-Ceranfelder



Material Einbaurahmen CNS 1.4301

	Artikel	Typ	Preis Einzelgerät €
	Einbau-Ceranfeld 2-Felder 2 x 4,0 kW 300 x 300 mm 8,0 kW, 400 V Kochfeldgröße 350 x 705 mm x 6 mm 400 x 800 mm	D-C-800-2	4.755,-
	Einbau-Ceranfeld 4-Felder 4 x 4,0 kW 300 x 300 mm 16,0 kW, 400 V Kochfeldgröße 695 x 705 mm x 6 mm 800 x 800 mm	D-C-800-4	6.148,-
	Einbau-Ceranfeld 6-Felder 6 x 4,0 kW 300 x 300 mm 24,0 kW, 400 V Kochfeldgröße 1095 x 705 mm x 6 mm 1200 x 800 mm	D-C-800-6	7.388,-

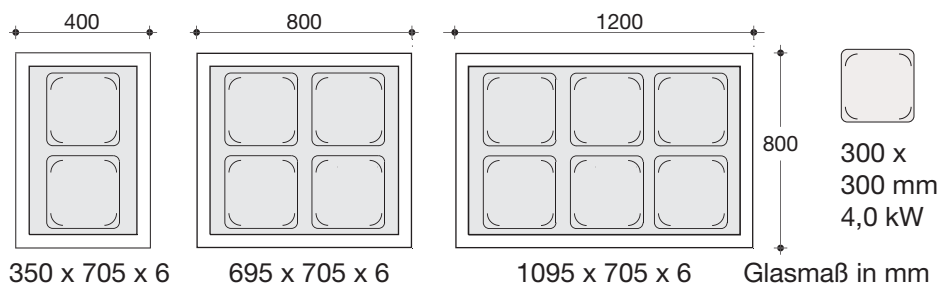



Gas • 700 mm Bautiefe

Einbau-Gasherde „EmaxxBurner“



Abdeckung und Gehäuse aus CNS 1.4301

	Artikel	Typ	Preis Einzelgerät €
	<p>2-Flammen-Einbau-Gasherde 2 x 5,5 kW Mit tiefgezogener Mulde 65 mm Brennerzündung mit Zündflamme mit CNS-Schieberosten 11,0 kW 450 x 700 x 199/328 mm</p>	<p>D-EB-600-G-2</p>	<p>1.919,-</p>
	<p>4-Flammen-Einbau-Gasherde 4 x 5,5 kW Mit tiefgezogenen Mulden 65 mm Brennerzündung mit Zündflamme mit CNS-Schieberosten 22,0 kW 800 x 700 x 199/328 mm</p>	<p>D-EB-600-G-4</p>	<p>3.119,-</p>
	<p>6-Flammen-Einbau-Gasherde 6 x 5,5 kW Mit tiefgezogenen Mulden 65 mm Brennerzündung mit Zündflamme mit CNS-Schieberosten 33,0 kW 1150 x 700 x 199/328 mm</p>	<p>D-EB-600-G-6</p>	<p>4.079,-</p>

5

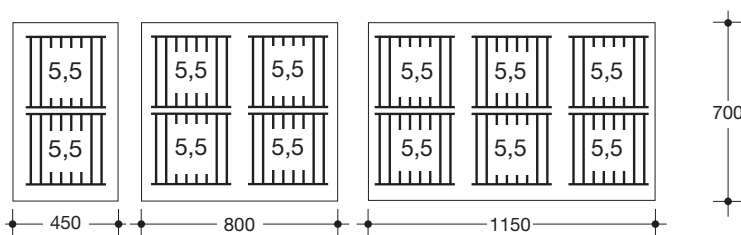



Gas • 800 mm Bautiefe

Einbau-Gasherde „*EmaxxBurner*“



Abdeckung und Gehäuse aus CNS 1.4301

	Artikel	Typ	Preis Einzelgerät €
	2-Flammen-Einbau-Gasherd 1 x 5,5 kW, 1 x 7,5 kW Mit tiefgezogener Mulde 65 mm Brennerzündung mit Zündflamme mit CNS-Schieberosten 13,0 kW 500 x 800 x 199/328 mm	D-EB-700-G-2	2.879,-
	4-Flammen-Einbau-Gasherd 2 x 5,5 kW, 2 x 7,5 kW Mit tiefgezogenen Mulden 65 mm Brennerzündung mit Zündflamme mit CNS-Schieberosten 26,0 kW 900 x 800 x 199/328 mm	D-EB-700-G-4	3.839,-
	6-Flammen-Einbau-Gasherd 3 x 5,5 kW, 3 x 7,5 kW Mit tiefgezogenen Mulden 65 mm Brennerzündung mit Zündflamme mit CNS-Schieberosten 39,0 kW 1300 x 800 x 199/328 mm	D-EB-700-G-6	4.799,-

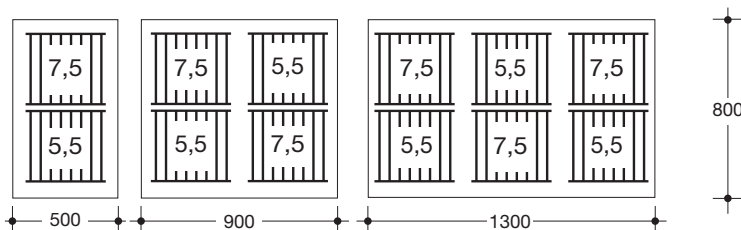



Gas • 550/900 mm Bautiefe Einbau-Gasherde „EmaxxBurner“

Abdeckung und Gehäuse aus CNS 1.4301

	Artikel	Typ	Preis Einzelgerät €
	1-Flammen-Einbau-Gasherde 1 x 7,5 kW Mit tiefgezogener Mulde 65 mm Brennerzündung mit Zündflamme mit CNS-Schieberost 7,5 kW 550 x 550 x 199/328 mm	D-EB-800-G-1	2.879,-
	2-Flammen-Einbau-Gasherde 2 x 7,5 kW Mit tiefgezogener Mulde 65 mm Brennerzündung mit Zündflamme mit CNS-Schieberosten 15,0 kW 500 x 900 x 199/328 mm	D-EB-800-G-2	3.119,-
	4-Flammen-Einbau-Gasherde 4 x 7,5 kW Mit tiefgezogenen Mulden 65 mm Brennerzündung mit Zündflamme mit CNS-Schieberosten 30,0 kW 900 x 900 x 199/328 mm	D-EB-800-G-4	4.079,-
	6-Flammen-Einbau-Gasherde 6 x 7,5 kW Mit tiefgezogenen Mulden 65 mm Brennerzündung mit Zündflamme mit CNS-Schieberosten 45,0 kW 1300 x 900 x 199/328 mm	D-EB-800-G-6	5.039,-



5

